



# Professional Radio

## P080

User Guide

68P64110B68A

Issue: April 2002



## CONTENTS

<b>Radio Overview</b> .....	<b>3</b>
Parts of the Radio .....	3
On-Off/Volume Knob .....	4
Channel Selector Knob .....	4
Push-to-Talk (PTT) Button .....	4
Microphone .....	4
LED Indicator .....	4
Programmable Buttons .....	4
Menu Keys .....	6
Keypad Keys .....	6
LCD Screen .....	6
Indicator Tones .....	8
Programmable Buttons' Audio Indicators ..	8
Improved Audio Features .....	8
Low Level Expansion (LLE) .....	8
Comanding .....	8
<b>Getting Started</b> .....	<b>9</b>
Battery Information .....	9
Battery Care and Tips .....	9
Recycling or Disposal of Batteries ...	10
Charging your Battery .....	10
Accessory Information .....	11

Attaching the Battery .....	11
Removing the Battery .....	11
Attaching the Antenna .....	12
Removing the Antenna .....	12
Attaching the Belt Clip .....	13
Removing the Belt Clip .....	13
Turning the Radio On or Off .....	14
Adjusting the Radio's Volume .....	14
Selecting a Radio Channel .....	14
Sending a Call .....	15
Receiving a Call .....	15
<b>Radio Call Information</b> .....	<b>16</b>
Repeater or Talkaround Mode .....	16
Setting Tight or Normal Squelch .....	16
Setting the Power Level .....	17
<b>Scan</b> .....	<b>18</b>
Starting or Stopping a Scan Operation ...	18
Talkback .....	19
Deleting a Nuisance Channel .....	19
Adding a Deleted Nuisance Channel back to the Scan List .....	19
Prioritization of a Scan List member ...	19

**Phone . . . . . 20**

Making a Phone Call . . . . . 20

    Entering the Phone Mode . . . . . 20

    Sending the Access Code . . . . . 20

    Sending the Phone Number . . . . . 21

    The Phone Conversation . . . . . 22

    Ending the Phone Call . . . . . 22

Phone List . . . . . 23

    Adding an Entry to the Phone List. . . . . 23

    Deleting an Entry. . . . . 23

    Editing an Entry. . . . . 24

**Audio/Tone Settings . . . . . 25**

General Instructions . . . . . 25

**Utilities . . . . . 26**

General Instructions . . . . . 26

**Safety Information . . . . . 27**

**Computer Software Copyright**

The products described in this manual may include copyrighted computer programmes stored in semiconductor memories or other media. Laws in the United States of America and other countries preserve for Motorola Europe and Motorola Inc. certain exclusive rights for copyrighted computer programmes, including the right to copy or reproduce in any form the copyrighted computer programme. Accordingly, any copyrighted computer programmes contained in the products described in this manual may not be copied or reproduced in any manner without the express written permission of the holders of the rights. Furthermore, the purchase of these products shall not be deemed to grant either directly or by implication, estoppel, or otherwise, any licence under the copyrights, patents, or patent applications of the holders of the rights, except for the normal non-exclusive royalty free licence to use that arises by operation of the law in the sale of the product.

# RADIO OVERVIEW

## PARTS OF THE RADIO

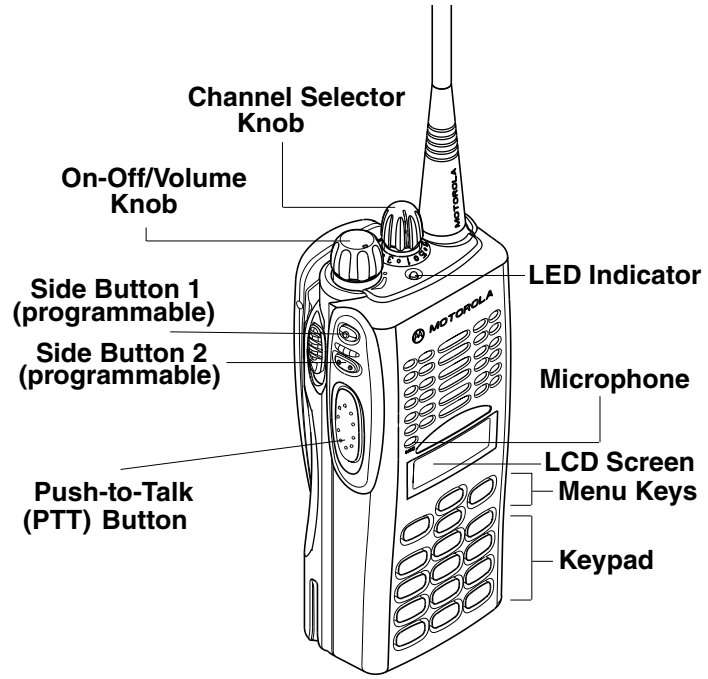

# RADIO OVERVIEW

**On-Off/Volume Knob**

Turns the radio on or off, and adjusts the radio's volume.

**Channel Selector Knob**

Switches the radio to different channels.

**Push-to-Talk (PTT) Button**

Press and hold down to talk; release it to listen.

**Microphone**

Speak clearly into the microphone when sending a message.

**LED Indicator**

Provides visual feedback on radio status. The operation of the indicator depends upon how the radio has been programmed by your dealer.

**Basic Features**

LED State/Colour	Indication
<b>Radio Call</b> Continuous Red Blinking Red	Sending message. Receiving message.
<b>Scan</b> Blinking Green	Scanning for activity.
<b>Low Battery</b> Blinking Red when sending message	Low battery level.

**Optional Transmit Power Level Indicator**

LED State/Colour	Indication
<b>Power Level</b> Continuous Red Continuous Green	Sending message in high power. Sending message in low power.

**Optional Transmit Battery Status Indicator**

LED State/Colour	Indication
<b>Battery Status (while pressing PTT)</b> Blinking Green Continuous Green Continuous Orange Continuous Red Blinking Red	Battery is fully charged. Battery is optimally charged. Battery is half charged. Low battery level. Very low battery level.

**Programmable Buttons**

Your radio's two side buttons can be programmed by your dealer as short-cut buttons for many of the radio's features.

Check with your dealer for a complete list of the functions your radio's programmable buttons support.

The table below shows the functions available by

- **short press** - quickly pressing and releasing the programmable buttons, or
- **long press** - pressing and holding the programmable buttons for a period of time (programmable by your dealer) before releasing, or

- **hold down**- pressing and holding down the programmable buttons while checking status or making adjustments.

Depending on how your radio has been programmed by your dealer, these functions are activated **EITHER** through short press **OR** long press, but **NOT** both.

Button	Short Press/Long Press	Hold Down
Monitor	—	Monitors the selected channel for any activity.
Volume Set	—	Sounds a tone for adjusting the radio's volume level.
Scan	Starts or stops the Scan operation.	—
Nuisance Channel Delete	Deletes a nuisance channel while scanning.	—
Power Level	Toggles your radio's transmit power level between High and Low settings.	—
Repeater/Talkaround	Toggles between using a repeater and transmitting directly to another radio.	—
Squelch	Toggles your radio's squelch level between tight and normal settings.	—
Keypad Lock*	Locks or unlocks your radio's keypad.	—
Phone	Makes a Phone Call.	—
Speed Dial	Accesses the phone numbers in your phone list.	—
Light	Turns on your radio's backlight.	—

\* Activated by long press only.

### Menu Keys

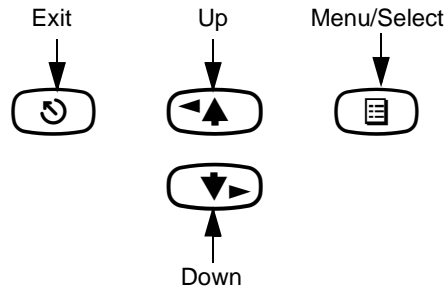

#### Menu/Select Key

Enters Menu Mode. When already in Menu Mode, makes Menu selections.

#### Exit Key

Backs up one level in the Menu hierarchy (short press); also exits the Menu Mode (long press).

#### Up Key

Used for scrolling when in Menu Mode. Used as a backspace key when editing.

#### Down Key

Used for scrolling when in Menu Mode. Moves the cursor right or inserts a space when editing.

### Keypad Keys

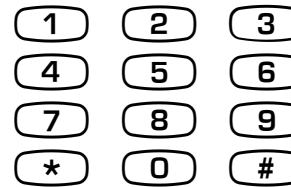

Used to dial a phone number or enter programming list entries.





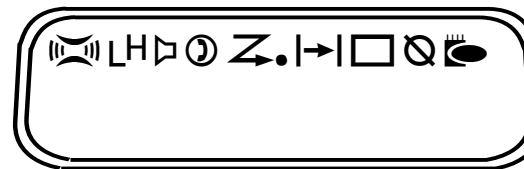

When entering information for the programming lists, each key can generate numeric information.





### LCD Screen

Used to display channel, menu as well as other iconic information.







Symbol	Name and Description
	<b>Companding Indicator</b> Indicates that companding is active.
	<b>Power Level Indicator</b> “L” is lit up when your radio is configured to transmit in Low Power, while “H” is lit up when your radio is configured to transmit in High Power.
	<b>Phone Indicator</b> Indicates that you are performing a Phone operation.
	<b>Scan Indicator</b> Indicates that you have activated the Scan feature.
	<b>Priority 1 Scan Indicator ( ● flashing )</b> During Scan, indicates that there is some activity on a Priority 1 channel.
	<b>Monitor Indicator</b> Indicates that you are monitoring the selected channel.

Symbol	Name and Description
	<b>Talkaround Indicator</b> When lit, indicates that you are not transmitting through the repeater. When not lit, you are transmitting through the repeater.
	<b>Programming Mode Indicator</b> Indicates that you are editing one of the Program Lists.
	<b>Keypad Lock Indicator</b> Indicates that your keypad is locked.
	<b>Option Board Indicator</b> Indicates that an option board is activated.

### INDICATOR TONES

High pitched tone  Low pitched tone

 Self Test Pass Tone

 Self Test Fail Tone

 Positive Indicator Tone

 Negative Indicator Tone

### PROGRAMMABLE BUTTONS' AUDIO INDICATORS

Some programmable keys function as toggles (alternating between two different choices). These keys use audio indicators to indicate the change.

Button	Positive Indicator Tone	Negative Indicator Tone
Scan	<b>Start</b> Scan operation	<b>Stop</b> Scan operation
Power Level	Radio transmits at <b>high</b> power	Radio transmits at <b>low</b> power
Squelch*	Radio operates in <b>tight</b> squelch	Radio operates in <b>normal</b> squelch

Button	Positive Indicator Tone	Negative Indicator Tone
Repeater/Talkaround	Radio <b>DOES NOT</b> use the repeater	Radio uses the repeater
Keypad Lock	Radio's keypad is <b>locked</b> .	Radio's keypad is <b>unlocked</b> .
* There is no visual indicator for the Squelch function.		

### IMPROVED AUDIO FEATURES

Your radio may be programmed by your dealer to utilise ONE of the following audio enhancement features.

#### Low Level Expansion (LLE)

LLE improves voice quality by reducing unwanted background noise when receiving a message.

#### Companding

Companding improves voice quality by compressing your voice at transmission, and expanding it when receiving. Companding also reduces extraneous noise. However, to enjoy this benefit, **ALL** transmitting and receiving radios must have this feature activated.

## GETTING STARTED

### BATTERY INFORMATION

#### Battery Care and Tips

This product is powered by a nickel-cadmium (NiCd) or a nickel-metal-hydride (NiMH) rechargeable battery.

The following battery tips will help you obtain the highest performance and longest cycle life from your Motorola rechargeable battery.

- Charge your new battery overnight (**14-16 hours**) before using it to obtain maximum battery capacity and performance.
- Charging in non-Motorola equipment may lead to battery damage and void the battery warranty.
- When charging a battery that is attached to the radio, turn the radio off to ensure a full charge.
- The battery should be at about 25°C (room temperature) whenever possible. Charging a cold battery (below 10°C) may result in leakage of electrolyte and ultimately, in failure of the battery.
- Charging a hot battery (above 35°C) results in reduced discharge capacity, affecting the performance of the radio. Motorola rapid-rate battery chargers contain a temperature-sensing circuit to ensure that the battery is charged within these temperature limits.
- New batteries can be stored up to two years without significant cycle loss. Store new/unused batteries in a cool dry area.
- Batteries which have been in storage should be charged overnight.
- Do not return fully charged batteries to the charger for an “extra boost”. This action will **significantly** reduce cycle life.
- Do not leave your radio and battery in the charger when not charging. Continuous charging will shorten battery life. (Do not use your charger as a radio stand.)
- For optimum battery life and operation use only Motorola brand chargers. They were designed to operate as an integrated energy system.

GETTING STARTED

### Recycling or Disposal of Batteries



At the end of its useful life, the NiCd battery can be recycled. However, recycling facilities may not be available in all areas.

Motorola endorses and encourages the recycling of all re-chargeable batteries. Contact your local Motorola dealer for further information.

### Charging your Battery

When the battery level is very low, a blinking red LED indicator lights up during transmit mode, and an alert tone sounds. You will need to recharge the battery before you can continue to use your radio.

Place the radio with the battery attached or the battery alone in the charger. The charger's LED indicator will indicate the charging progress.

**NOTE:** Since new batteries or batteries that have not been used for several months could prematurely indicate full charge (solid green LED), charge the batteries for 14 to 16 hours prior to initial use to achieve optimal performance.

LED color	Status
Single flash of Green	Successful charger power-up.
Flashing Red*	Battery is unchargeable.
Flashing Yellow	Charger is getting ready to charge.
Red	Battery is charging.
Flashing Green†	Battery is 90% charged.
Green	Battery is fully charged.

\* Remove the battery from charger and use a pencil eraser to clean the four metal contacts on the bottom of the battery. Place the battery back into the charger. If the LED indicator continues to flash red, replace the battery.

† A standard battery may require one hour to charge to 90% capacity.

## ACCESSORY INFORMATION

### Attaching the Battery

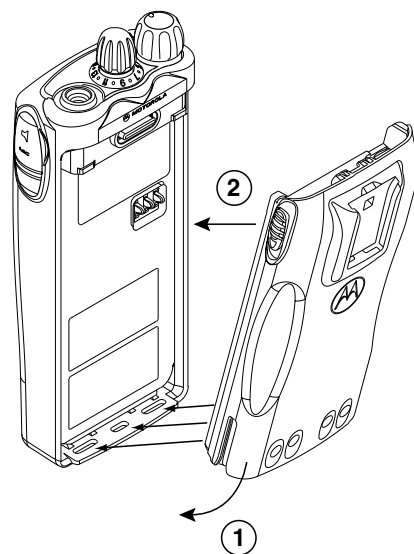

1. Fit the extensions at the bottom of the battery into the slots at the bottom of the radio's body.
2. Press the top part of the battery toward the radio until you hear a click.

### Removing the Battery

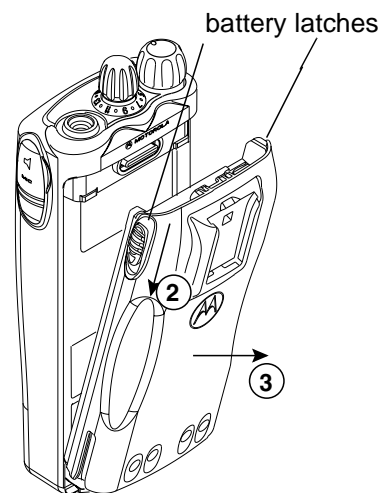

1. Turn off the radio, if it is turned on.
2. Slide the battery latches on both sides of the battery downwards.
3. Pull the top part of the battery away from the radio body.

GETTING STARTED

### Attaching the Antenna

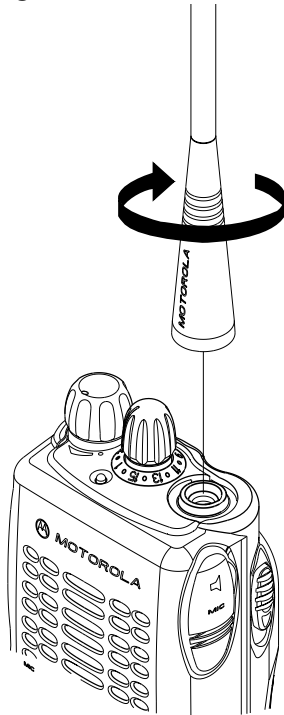

Turn the antenna clockwise to attach it.

### Removing the Antenna

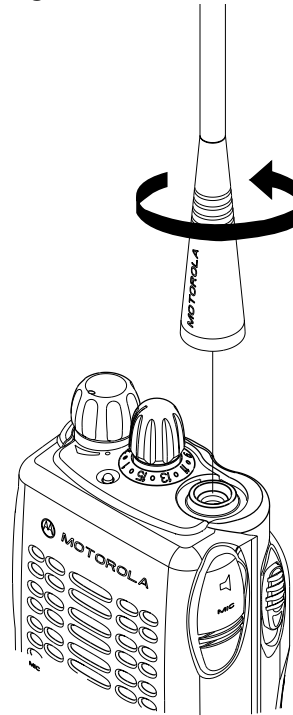

Turn the antenna counter-clockwise to remove it.

### Attaching the Belt Clip

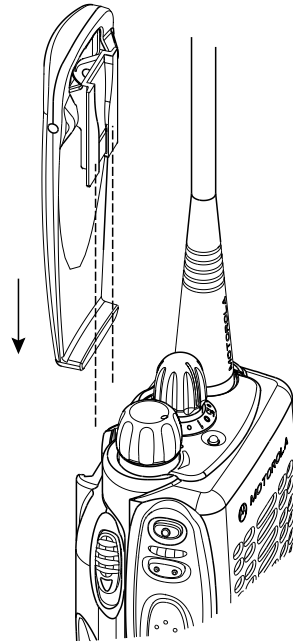

1. Align the grooves of the belt clip with those of the battery.
2. Press the belt clip downward until you hear a click.

### Removing the Belt Clip

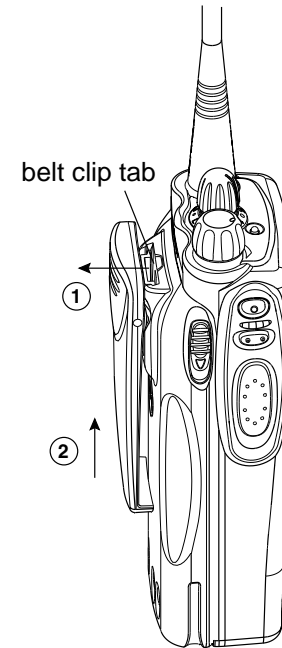

1. Use a key to press the belt clip tab away from the battery.
2. Slide the belt clip upward to remove it.

GETTING STARTED

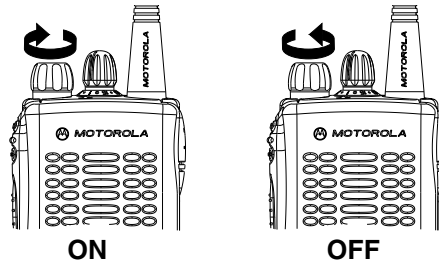
**TURNING THE RADIO ON OR OFF**

1. Turn the **On-Off/Volume Control** knob clockwise to turn on the radio. You will hear the Self Test Pass Tone (  ) and see a green LED if the radio powers up successfully. If the radio fails its self test, you will hear the Self Test Fail Tone (  ). Switch off and on again and if fault persists contact your dealer.
2. To turn off the radio, turn the **On-Off/Volume Control** knob counter-clockwise, until you hear a click.

**ADJUSTING THE RADIO'S VOLUME**

If one of the radio side buttons has been programmed as a Volume Set button by your dealer, it may be used as follows:

1. Press and hold the preprogrammed **Volume Set** button; you will hear a continuous tone.
2. Turn the **On-Off/Volume Control** knob and adjust the volume level.
3. Release the preprogrammed **Volume Set** button.

**SELECTING A RADIO CHANNEL**

Your radio offers 16 channels for easy access to required conventional channels. Some channels on your radio may not be programmed. Check with your dealer for more information.

Turn the **Channel Selector** knob clockwise or counter-clockwise until you reach the desired channel.



## SENDING A CALL

1. Turn your radio on.
  2. Use the **Channel Selector** knob to select the desired channel.
  3. Hold the radio in a vertical position, press the **PTT** button, and talk at a distance of about 2.5 to 5 cm (one to two inches) from the microphone.
  4. Release the **PTT** button to listen.
- 

## RECEIVING A CALL

1. Turn your radio on.
  2. Adjust the radio's volume.
  3. Switch to the desired channel.
  4. If at any time a call comes through, you will hear the call at the volume level you have set.
-

## RADIO CALL INFORMATION

### REPEATER OR TALKAROUND MODE

Talkaround Mode enables you to communicate with another radio when either:





- the repeater is not operating  
—or—
- your radio is out of the repeater's range but within communicating distance of another radio.

**NOTE:** The  symbol will appear on the LCD screen when Talkaround Mode is selected.



To select either Repeater Mode or Talkaround Mode:

Press the **Repeater/Talkaround** button (only available if programmed by your dealer) to toggle between the two modes. A positive indicator tone indicates that the radio is in talkaround mode, while a negative indicator tone indicates that the radio is in repeater mode.

—or—

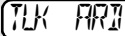
1.  to enter Menu Mode.
2.  or  until 

3.  to select 

4.  or  until (talk through repeater), 

or until (talk directly without going through repeater). 















5.  to select the desired option.

### SETTING TIGHT OR NORMAL SQUELCH

Use this feature to filter out nuisance (unwanted) calls and/or background noise. However, tightening squelch could cause calls from remote locations to be filtered out as well. In this case, normal squelch may be more desirable. To select tight or normal squelch:

Press the **Squelch** button (only available if programmed by your dealer) to toggle between tight and normal squelch. A positive indicator tone indicates that the radio is operating in tight squelch, while a negative indicator tone indicates that the radio is operating in normal squelch.

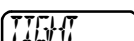
—or—

1.  to enter Menu Mode.
2.  or  until 
3.  to select 
4.  or  until 
5.  to select 
6.  or  until   
(tighten channel's squelch),  
or until   
(channel operates under normal squelch).
7.  to select the squelch setting.

### SETTING THE POWER LEVEL















Your radio has a predefined transmit power level that can be changed.

- *High power (H icon)* allows the radio to transmit over greater distances.
- *Low power (L icon)* conserves the battery's charge.

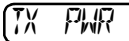
To set the power level:

Press the **Power Level** button (only available if programmed by your dealer) to toggle between *low* and *high* transmit power level. A positive indicator tone indicates that the radio is in high power mode, while a negative indicator tone indicates that the radio is in low power mode.

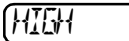
—or—

1.  to enter Menu Mode.
2.  or  until 
3.  to select 
4.  or  until 
5.  to select 
6.  or  until   
(to transmit at high power),  
or until   
(to transmit at low power).
7.  to select the power level.

RADIO CALL INFORMATION

## SCAN

You can monitor several channels in order to receive any call that is transmitted on any of these channels. Sixteen different channels can be programmed into each scan list by the dealer.

Once the radio's scan operation is activated and the radio detects a call coming through a channel in its scan list, it switches to that channel for you to receive the call.

### STARTING OR STOPPING A SCAN OPERATION

The **Z** symbol, and the channel you are transmitting on, will appear on the LCD screen when you start a scan operation.











The LED indicator blinks green during a scan operation.

**NOTE:** If you enter Menu Mode while the radio is scanning, scanning will stop. It will resume when you exit Menu Mode.

To start or stop a scan operation:

1. Press the **Scan** button (only available if programmed by your dealer) to start a scan operation. You will hear a positive indicator tone.
2. Press the preprogrammed **Scan** button again to stop the scan operation. You will hear a negative indicator tone.

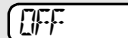
—or—

1.  to enter Menu Mode.
2.  or  until 
3.  to select 
4.  or  until (to start a scan operation),   
or until (to stop a scan operation), 
5.  to select the desired option.

**NOTE:** The LED indicator will blink (green) during a scan operation.

## TALKBACK

If the programmable Talkback option is set, you can respond to any calls received during the scan operation by pressing the PTT before the programmed hang-time ends. Check with your dealer for details.

## DELETING A NUISANCE CHANNEL

If a channel continually generates unwanted calls or noise (a “nuisance” Channel), you can temporarily remove it from the scan list by performing a *Nuisance Channel Delete* operation.

1. While the radio is on the Nuisance Channel, press the **Nuisance Channel Delete** button (only available if programmed by your dealer) until you hear a tone.
2. Release the **Nuisance Channel Delete** button. The nuisance channel is deleted.

**NOTE:** You cannot perform a *Nuisance Channel Delete* on a priority channel or if there is only one remaining channel in the scan list.

## ADDING A DELETED NUISANCE CHANNEL BACK TO THE SCAN LIST

1. Press the **Scan** button to stop the scan operation.
2. Press the **Scan** button again to re-start the scan operation. The Deleted Nuisance Channel is reinstated to the scan list.

## PRIORITIZATION OF A SCAN LIST MEMBER

You may want your radio to check a particular channel more frequently for calls. Prioritization of scan list members is done by your dealer using the Customer Programming Software. Check with your dealer for details.

Priority Channel	Scanning Sequence
None specified	Ch1 → Ch2 → Ch3 → Ch4 →...Ch1
Channel 2	Ch2 → Ch1 → Ch2 → Ch3 → Ch2 → Ch4 → Ch2 →...Ch1

Even though your radio has switched to a non-priority channel, your radio will still check for activity on the priority channel. If activity is detected the radio will switch to the priority channel.



## PHONE

You can use your radio to connect to a phone line to make a phone call.

To do this, your radio must send an access code to a station that connects it to a phone line. After you have finished your call, the radio has to send a deaccess code to shutdown the connection to the phone line.

### MAKING A PHONE CALL

You can make a phone call by using the menu or by using the programmed Phone button (if Phone operation is permitted on the current channel). The  icon will light up on the LCD screen when you are in Phone mode.

A complete phone session consists of

- entering the Phone mode
- sending the access code
- sending the phone number
- having the phone conversation
- ending the phone call.



#### Entering the Phone Mode

Before you can make a phone call, you must enter the radio's Phone mode.

1. Press the Phone button.

To enter the Phone mode via the menu:

1.  to enter Menu Mode.

2.  or  until



3.  to select



You will see the last phone number dialed; for example



### Sending the Access Code

Your radio can be programmed to send the access code in any of the following ways:

- manual
- automatic delayed
- automatic immediate.

Check with your dealer for more details.

Method	Steps to Take
Manual	Dial the access code from the keypad.
Automatic Delayed	Press and release the PTT; the radio automatically sends the preprogrammed access code.
Automatic Immediate	You do not have to do anything; the radio immediately sends the access code when it enters phone mode.

### Sending the Phone Number

After the access code is sent, you should wait for a dialling tone before sending your phone number.

You can send

- a phone number that is stored in the radio, or
- a new number.

Additionally, depending on how your radio is programmed, if you use the keypad to send a number, the radio can send the numbers in one of the following ways:

- live dial
- buffered dial.

Check with your dealer for details.

### Sending a Stored Phone Number

You can access the stored phone numbers by

- recalling the last number dialled,
- using the phone list, or
- using the speed dial feature.

Method	Steps to Take
Last Number* Redial	Press and release the PTT; the radio sends the last number dialled.

Method	Steps to Take
Phone List	<ol style="list-style-type: none"> <li>1. Press  or  to scroll the phone list until you reach the desired phone number.†</li> <li>2. Press and release the PTT to send the number.</li> </ol>
Speed Dial	<ol style="list-style-type: none"> <li>1. Press and release the programmed Speed Dial button.</li> <li>2. Press the numbered keys (1-9) corresponding to the first nine phone numbers in the phone list. Press "0" if you want the last number dialled.</li> <li>3. If your radio uses buffered dial, press and release the PTT.</li> <li>4. The radio sends out the phone number.</li> </ol>

\* The method described is not applicable for radios which manually send the access code; these radios can access this number from the phone list or the speed dial.

† For radios that manually send the access code, press the Down Key once to access the last number dialled.



### Sending a New Number

You enter the phone number by pressing the relevant keys on the keypad.

Method	Steps to Take
Live Dial	Enter the phone number by using the keypad; the radio sends out the numbers as the keys are pressed.
Buffered Dial	<ol style="list-style-type: none"> <li>1. Enter the phone number by using the keypad; the radio saves the selected numbers in a buffer.</li> <li>2. Press and release the PTT; the radio sends out the numbers in its buffer.</li> </ol>

### The Phone Conversation

Once the radio has connected to the intended party, you can begin the conversation. Even though this is a phone call, your conversation mimics a radio call (that is, both parties speak in turn).

1. Press and hold the PTT, while talking into the microphone.
2. Release the PTT when you finish what you want to say, and wait for the response.
3. Repeat steps 1 and 2 until the conversation ends.

### Ending the Phone Call

Just as the radio needs to send the access code when starting a phone call, the radio needs to send the deaccess code to end the phone call.

The radio can send the deaccess code in any of the following ways:

- manual, and
- automatic.

Check with your dealer for details.

1. If your radio sends the deaccess code manually, dial the deaccess code from the keypad.
2. Press the **Phone** button to exit phone mode.

**NOTE:** Radios using the automatic method will send the deaccess code automatically.

or

Exit the phone mode using the menu:

 to exit phone mode and return to



or

Hold  to exit the *Menu Mode*.

**NOTE:** Radios using the automatic method will send the deaccess code automatically.



















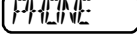

## PHONE LIST

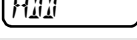

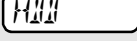
Your radio can store a list of frequently accessed phone numbers. The G icon will light up on the LCD screen when you edit the phone list.

**NOTE:** The radio will not receive any calls when you are editing the phone list.

### Adding an Entry to the Phone List

1.  to enter Menu Mode.
  2.  or  until 
  3.  to select 
  4.  or  until 
  5.  to select 
  6.  or  until 
  7.  to select 
- You will see 

8. Use the keypad to enter the phone number. Press the numeric keys to enter the numbers. You can also add a dash (press ) and a Pause Indicator (press and hold the  key until the # character on the LCD screen changes to a "P").











9.  to store the phone number.  
 again to confirm its storage.



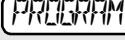









10.  to return to 

or











Hold  to exit Menu Mode.















### Deleting an Entry

1.  to enter Menu Mode.
2.  or  until 
3.  to select 
4.  or  until 
5.  to select 

6.  or  until 
  7.  to select 
  8.  or  until you see the entry you wish to delete.
  9.  to select the entry.  
 again to confirm the deletion.
  10.  to return to 
- or*
- Hold  to exit Menu Mode.

### Editing an Entry

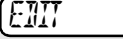





1.  to enter Menu Mode.
2.  or  until 
3.  to select 
4.  or  until 
5.  to select 







6.  or  until 
  7.  to select 
  8.  or  until you see the entry you wish to edit.
  9.  to select the entry.  
*or* until  
(to edit the entry's phone number), 
  - or* until  
(to edit the entry's location in the phone list), 
  11.  to select the edit type.
  12. Use the keypad to edit the entry. See *Keypad Keys* on page 6.
  13.  to store the information.
  14.  to return to 
- or*
- Hold  to exit Menu Mode.

## AUDIO/TONES SETTINGS

The Audio/Tones menu allows you to customize the audio and tone settings on your radio.

### GENERAL INSTRUCTIONS

1.  to enter Menu Mode.
2.  or  until 
3.  to select 

4.  or  until you see the audio/tone setting you wish to change.
5.  to select the tones setting. You will see the current status of the setting.
6.  or  to see the available optional settings.
7.  to select the desired setting.







Use instructions above to change your radio's audio and tones settings shown in the table below.







Menu Items	Optional Settings	Function
ALERT	ON OFF	Allows you to turn all tones on or off.
KEYPAD	ON OFF	Allows you to turn the tones associated with the radio keys on or off.

## UTILITIES

The Utilities menu allows you to customize some general settings on your radio.

### GENERAL INSTRUCTIONS

1.  to enter Menu Mode.
2.  or  until 
3.  to select 

4.  or  until you see the setting that you wish to change.
5.  to select the setting to change. You will see the current status of the setting.
6.  or  to see the available optional settings.
7.  to select the desired setting.

Use the instructions above to change your radio settings shown in the table below.

Menu Items	Optional Settings	Function
SQUELCH	NORMAL TIGHT	Allows you to change the squelch setting of the radio between normal and tight.
TX PWR	HIGH LOW	Allows you to change the power level of the radio between high or low.
LIGHT	ON OFF	Allows you to turn the back-light feature of the radio on or off.
SOFTWARE		Allows you to identify the version number of the software within the radio.

## SAFETY INFORMATION

**Note:** **Before** using this radio, refer to Important Safety and General Information contained in the separate booklet 68P64117B25\_ enclosed with your radio.

SAFETY INFORMATION



**NOTES**



**28**